



KANOMAX

ANEMOMASTER

MODEL A031/A041/A034/A044

Operation Manual

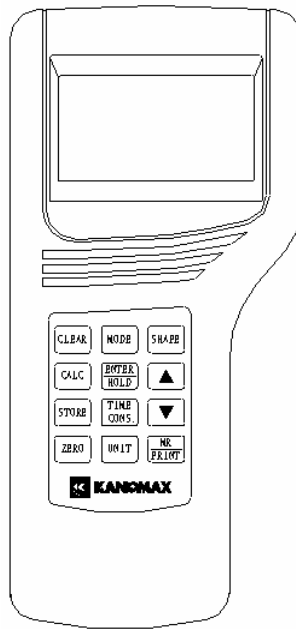

Read this manual carefully and understand the warnings described in this manual before operating the product.

Keep this manual handy for future reference.



02001

06.07

No. 603101

Thank you for purchasing a product of Kanomax, Inc.

Please read this operation manual carefully and operate the instrument appropriately by following the instructions given in this manual.

List of Components

■ Standard

Item	Model	Qty.	Feature and Functions
Main Body & Probe	A031	1	Straight probe. Measures air velocity, air temperature and volumetric flow rate.
	A034	1	Articulating probe. Measures air velocity, air temperature and volumetric flow rate.
	A041	1	Straight probe. Measures air velocity, air temperature, volumetric flow rate and differential pressure.
	A044	1	Articulating probe. Measures air velocity, air temperature, volumetric flow rate and differential pressure.
Operation Manual	—	1	
RS232C Cable	—	1	
Software CD	—	1	
Carrying Case	—	1	
AC Adapter	STC9R0V0300-A	1	
Manganese AA Batteries	—	6	

■ Options

Item	Model	Function
Analog Output	—	Analog Output Terminal
Printer	DPU-H245	For printing out stored data.
Printer Cable	6000-03	Printer cable for connecting the instrument with the printer.

Important Safety Information

[Classifications]



Danger: To Prevent Serious Injury or Death

Warnings in this classification indicate danger that may result in serious injury or death if not observed.



Caution: To Prevent Damage to the Product

Warnings in this classification indicate risks of damage to the product that may void the product warranty if not observed.

[Description of Symbols]



- △ This symbol indicates a condition (including danger) that requires caution. The subject of each caution is illustrated inside the triangle (e.g., high temperature caution symbol shown on the left).



- ⊘ This symbol indicates prohibition. Do not take a prohibited action shown inside or near this symbol (e.g., disassembly prohibition symbol shown on the left).



- This symbol indicates a mandatory action. A specific action is given near the symbol.

Danger



Do not use near flammable gas

- **Never bring the probe close to a flammable gas atmosphere.**

--- The heated sensor may cause fire or explosion.

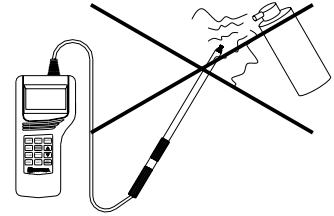

Do not modify / disassemble

- **Never disassemble, modify or repair the product.**

--- Failure to observe the above may cause short circuit and/or other failure that will affect the performance.



Handle Properly

- **Carefully follow the instructions provided in this Manual.**

--- Failure to observe the instructions may lead to electrical shock, fire or damage to the instrument.



- **If abnormal noise, smell or smoke is observed, or if liquid has entered the instrument, turn off the instrument immediately, and remove the batteries or pull out the plug.**

--- There is possibility of malfunction, electric shock, and fire.
Please contact your local distributor or our service center for repair.



Prohibition

- **Do not use the instrument in a water vapor atmosphere.**

--- Failure to observe the above may cause electrical shock, fire, or damage to the sensor.

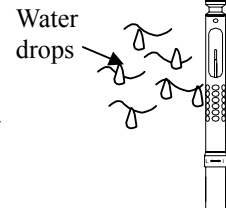

High Temperature Warning

- **Never touch the sensor.**

--- The sensor is heated during operation.
Touching the heated sensor may cause burns, and may also damage the sensor itself.

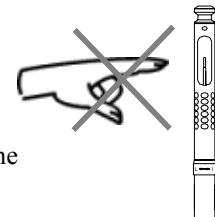

Caution



- **Always unplug the instrument from the electrical outlet when the instrument is not in use.**

--- Failure to do so may cause electrical shock, fire or circuit damage.



Handle Properly

- **Remove the batteries from the battery compartment when storing the instrument.**
- **Do not leave exhausted batteries in the battery compartment.**

--- Failure to do so may cause battery leakage.



Prohibited
Installation

- **Do not use or leave the instrument in a high temperature/ humidity environment, or in a dusty environment.**
- **Do not leave the instrument under direct sunlight for a prolonged period.**

--- The instrument may not function properly out of the specified operating conditions.

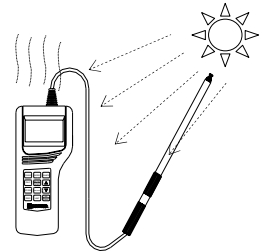

Prohibition

- **Do not wipe the instrument with a volatile solvent.**

--- The body may deform or deteriorate. Use soft dry cloth to remove stains. If stains persist, soak the cloth in a neutral detergent and wipe the instrument with the soft cloth. Never use volatile solvents such as thinner or benzene.



Prohibition

- **Do not apply strong shock or place/drop anything heavy on the instrument.**

--- Failure to observe the above may cause damage or malfunction to the instrument

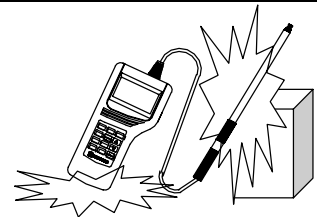

- **Discharge any built-up static electricity from your body before touching the instrument.**

--- The built-up static electricity may influence the readings and cause damage to the circuit.

Table of Contents

1. Part Names and Functions	1
1.1 Overview	1
1.2 Main Body	2
1.3 Touch Panel	3
1.4 Probe	4
2. Getting Started	5
2.1 Installing Batteries	5
2.2 Turning ON/OFF the Power	6
2.3 Precautions for Measurements	8
2.3.1 Air Velocity Measurement Precautions	8
2.3.2 Air Temperature Measurement Precautions	8
2.3.3 Differential Pressure Measurement Precautions (A041, A044)	8
3. Duct Shape and Size	10
4. Measurement.....	11
4.1 Changing the Measurement Mode	11
4.2 Hold the Reading	12
4.3 Setting the Time Constant	13
5. Data Storage and Statistical Calculation	14
5.1 Storing Measurement Data	14
5.2 Data Storage and Statistical Calculation Procedure	15
5.3 Viewing and Deleting Stored Data	17
6. Setting the Measurement Unit and Baud Rate.....	18
7. Data Output	19
7.1 Printing Out the Measurement Data	19
7.1.1 Preparation for Print Out.....	19
7.1.2 Printing Directly from the Measurement Mode	20
7.1.3 Printout Examples (Measurement Mode)	20
7.1.4 Printing Out Stored Data.....	21
7.1.5 Printout Examples (Stored Data)	22
7.2 Analog Output (Optional)	22
7.3 S232C Serial Communication.....	23
8. Cleaning the Probe	24
9. Specifications.....	25
10. Measurement Principles	26
11. Air Velocity Compensation	28
11.1 Influence of Air Temperature	28
11.2 Influence of Atmospheric Pressure	28
11.3 Influence of Air Composition.....	28
12. Probe Directivity (Air Velocity)	29
12.1 Horizontal Directivity	29
12.2 Vertical Directivity	29

13. Troubleshooting.....	30
14. Warranty and After Service.....	32
15. Contact Information.....	34

1. Part Names and Functions

1.1 Overview

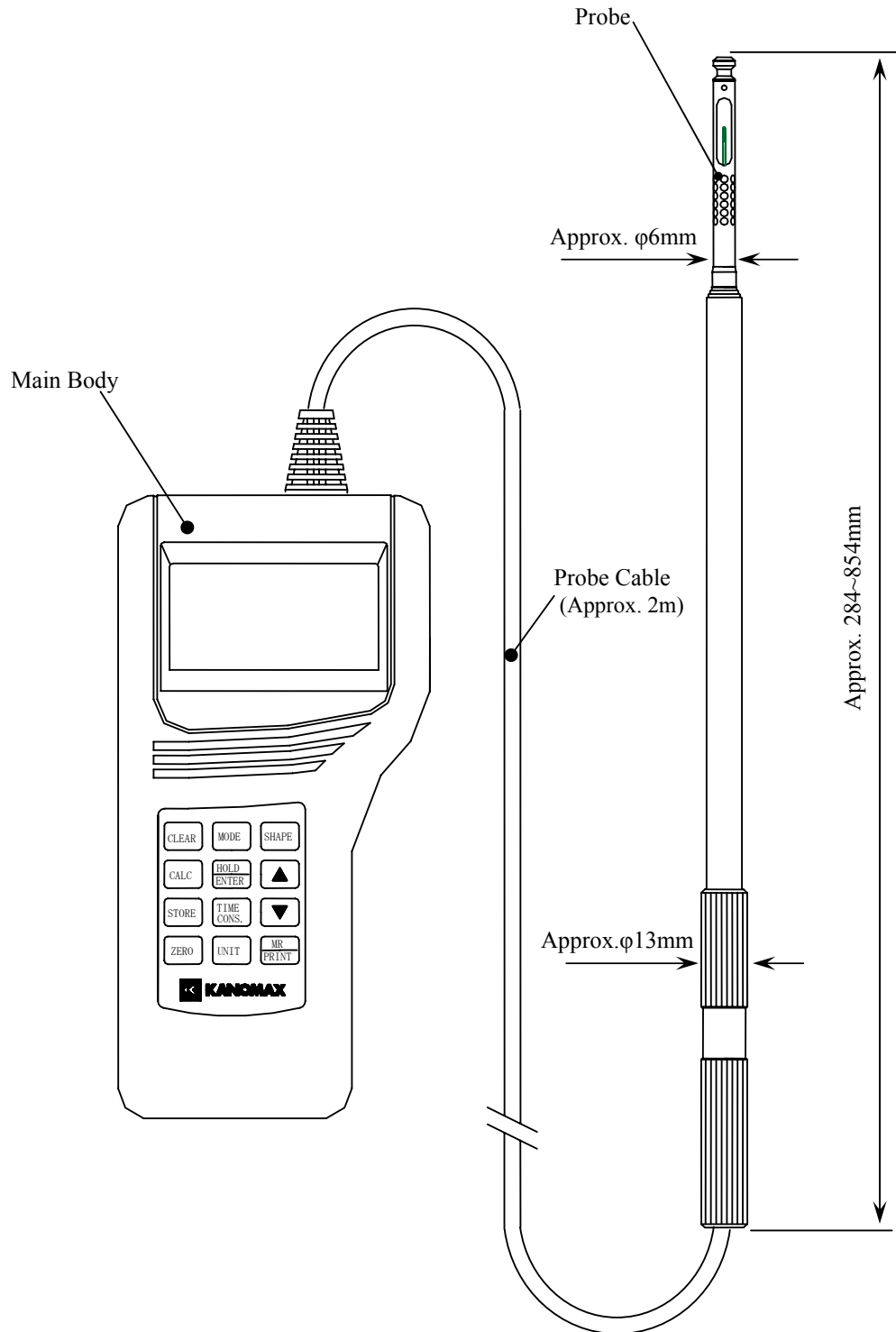

1.2 Main Body

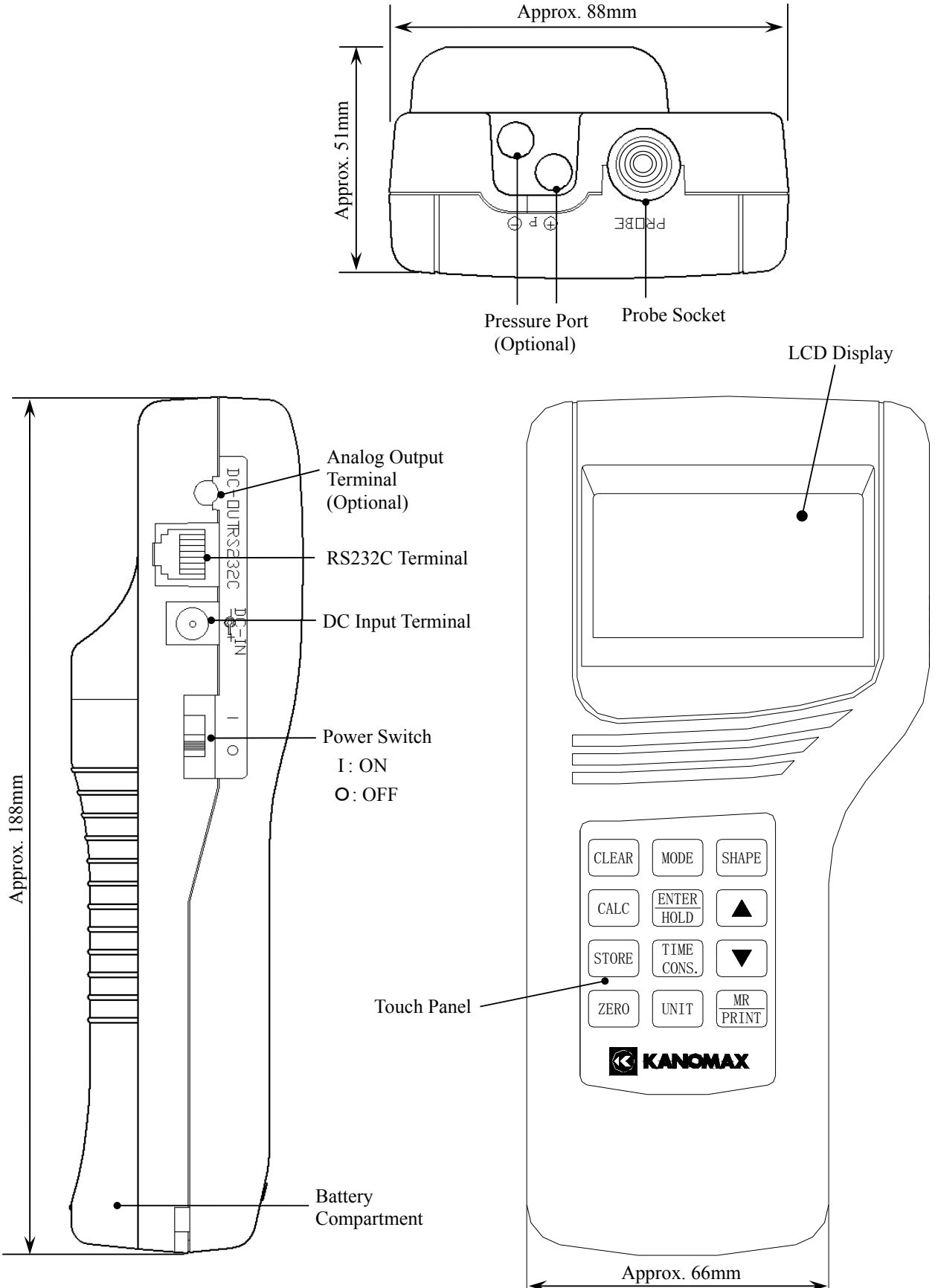

1.3 Touch Panel

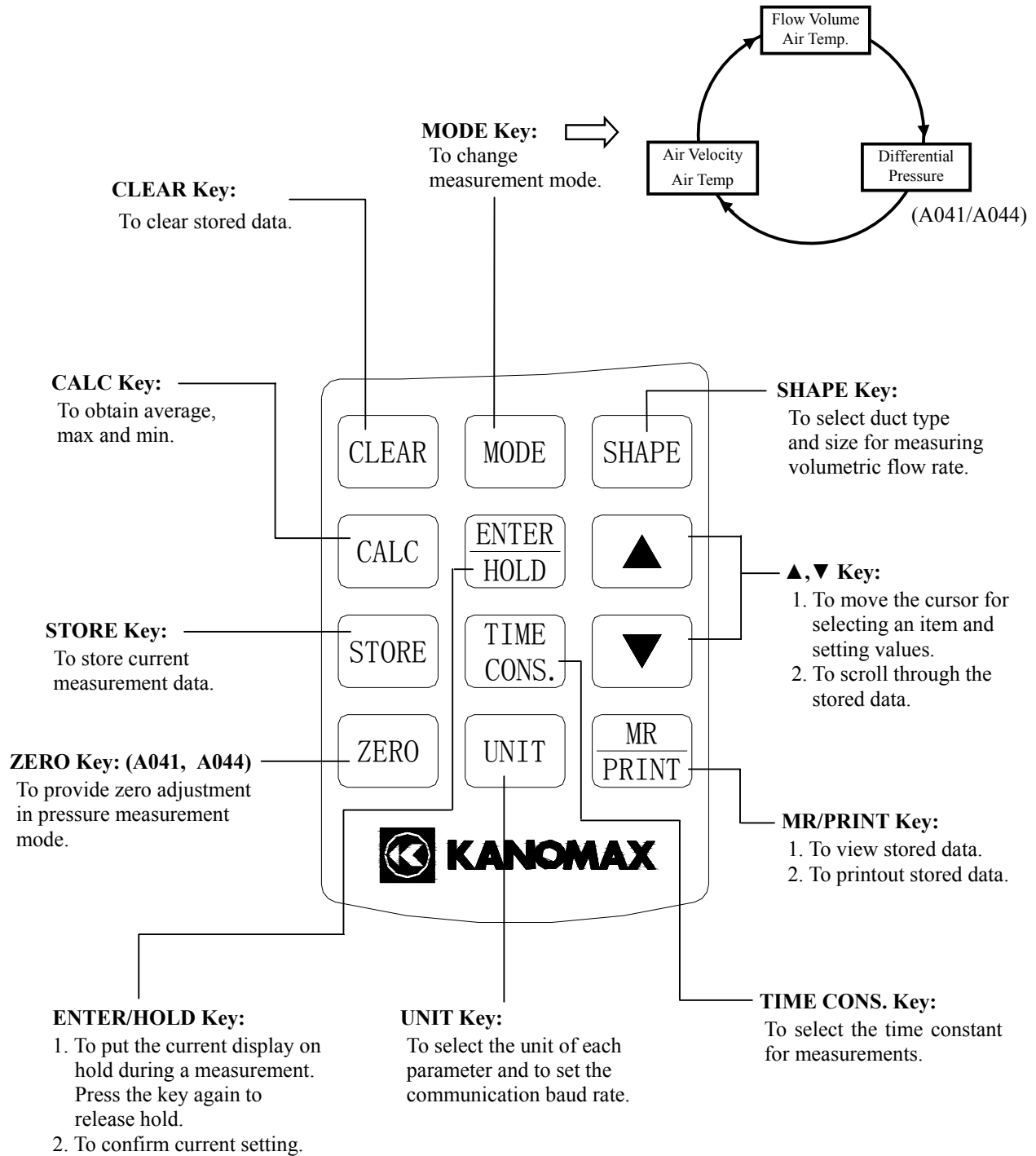

1.4 Probe

Straight Probe (ModelA031/A041)

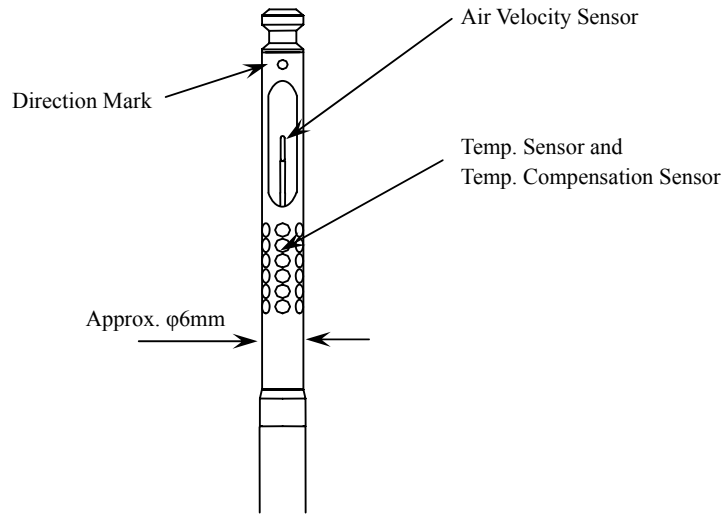

Articulating Probe (ModelA034/A044)

How to extend the Articulating Probe:

1. Hold the upper part ① of the probe, and unscrew ②.
2. Pull out the flex-neck ③.
Fix the probe in its extended position by holding ① and turning ④.
3. Slowly bend the flex-neck. (⑤&⑥)

Caution:

Do not excessively bend the flex-neck or apply excessive force.
When the instrument is not in use, the probe must be returned to its original position (the flex-neck stored) to avoid possible damage.

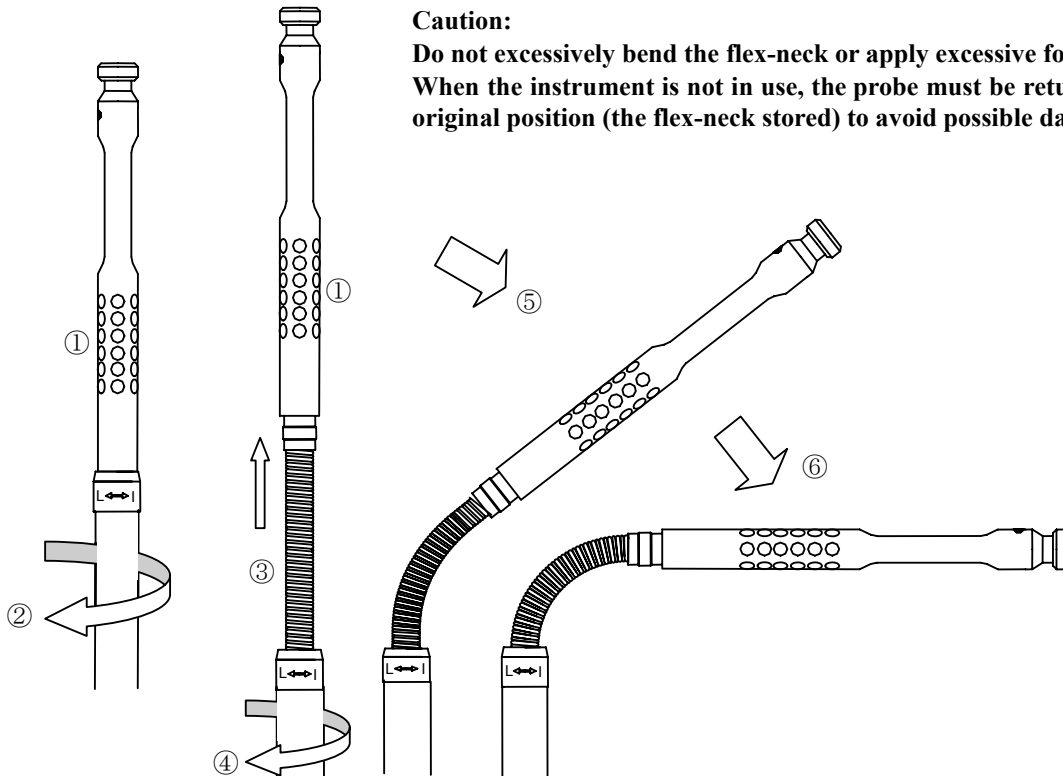

2. Getting Started

2.1 Installing Batteries

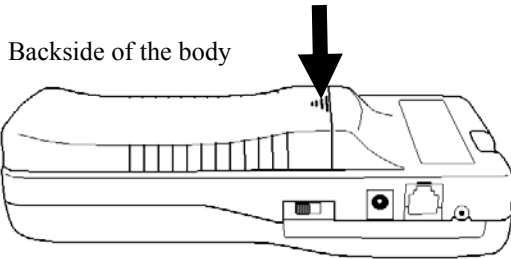

1. Press down the battery cover with your finger as shown left.

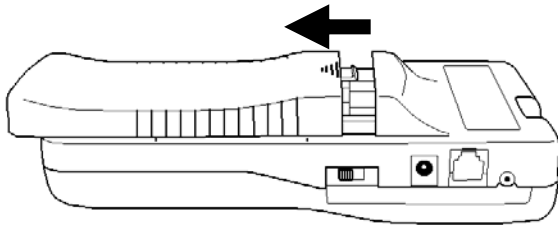

2. Slide the cover toward the bottom of the instrument until it stops.

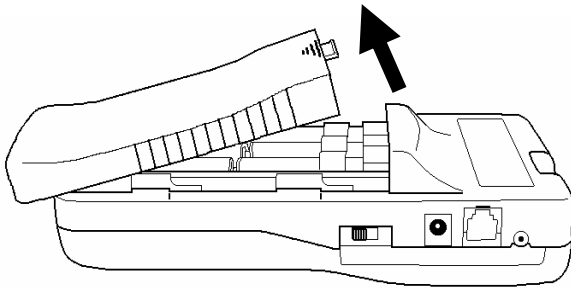

3. Lift the cover away from the body.

Types of Batteries that can be Used

- Manganese (R6), AA batteries
- Alkaline (LR6), AA batteries
- Ni-Cd, AA batteries

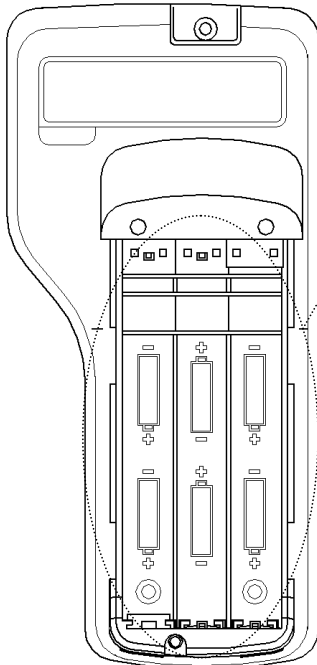

4. Insert the batteries by observing the polarity. The instrument requires **six (6) AA size batteries**. Types of batteries that can be used are: **Manganese (R6), Alkaline (LR6) or Ni-Cd batteries**.

The six (6) batteries must be of the same type. Do NOT mix different types of batteries. Failure to observe this may cause battery leakage or damage to the instrument.

* Batteries CANNOT be recharged by the AC adapter.

5. Put the cover back on by reversing the above procedures.

2.2 Turning ON/OFF the Power

The power switch for turning ON/OFF the instrument is located at the side of the instrument.

When powered up, the LCD test screen will be displayed, which will switch to the Air Velocity / Air Temperature measurement screen in approx. 2 seconds.

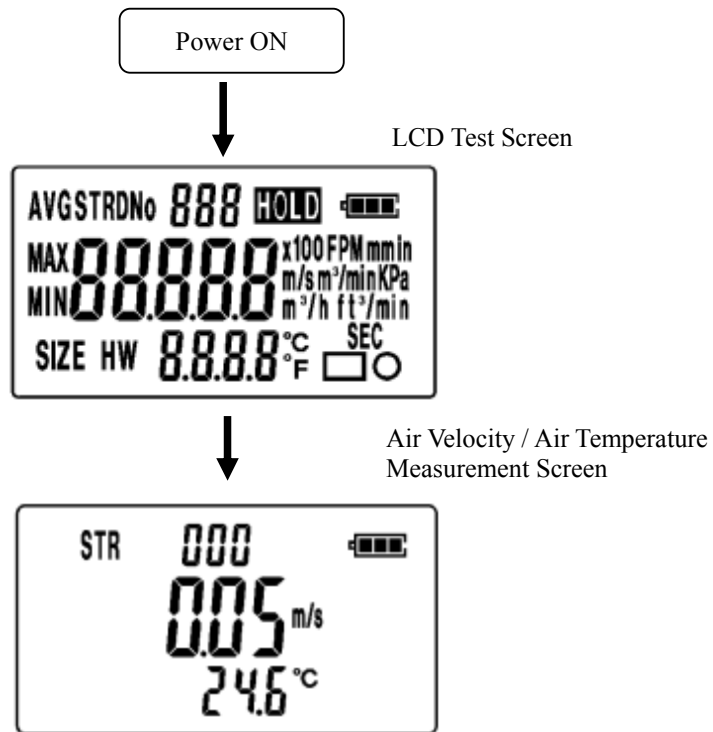
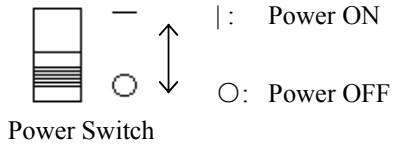

■ Battery Level Indicator

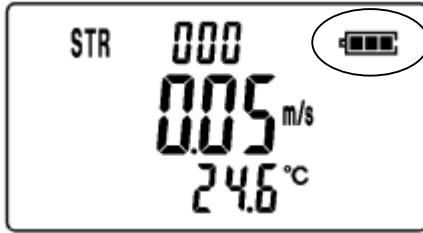

Check the “battery level indicator” to confirm the remaining battery level. The battery consumption rate largely depends on the measured air velocity. When the battery drops to a level requiring replacement, the indicator will start blinking.

The screen may freeze if high velocity is measured after the battery level indicator starts blinking.

The indicator changes as below according to the remaining battery level:

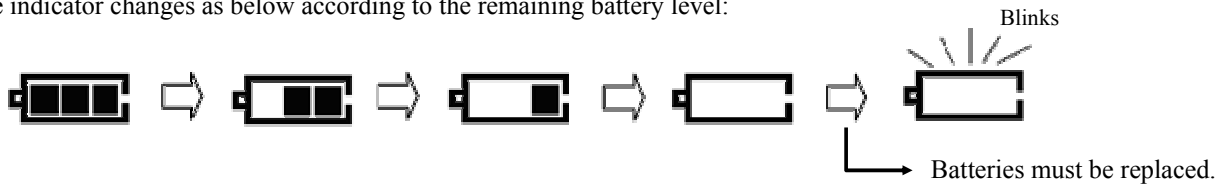

2.3 Precautions for Measurements

2.3.1 Air Velocity Measurement Precautions

- Probe has its own directivity characteristics. Make sure that the direction mark is facing against the airflow (for details of the directivity characteristics, refer to Section 12 “Probe Directivity”). If you are not sure of the airflow direction, slowly rotate the probe and select the point where you get the maximum velocity reading,
- The probe compensates air velocity change due to temperature change by using the air velocity sensor with the temperature compensation sensor. In order to obtain this compensation effect, it is required that both sensors are evenly exposed to the airflow under the same temperature condition.
- For measurements in an environment with rapid temperature change, you must wait for the reading to become stable after measuring for more than 20 seconds before taking the data.

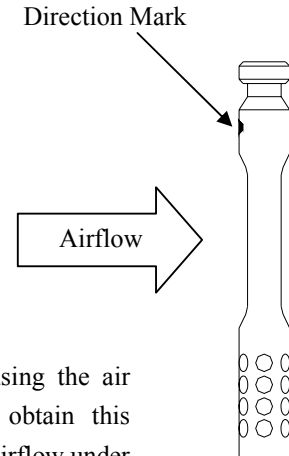



2.3.2 Air Temperature Measurement Precautions

- The response time for temperature measurement improves as the air velocity increases. The normal response time is approximately 5 seconds when the air velocity is 1m/s. You must wait for the reading to become stable before taking the data.
- When a measurement is performed in a no-airflow condition, the air temperature reading may become higher than actual due to the heat generated by the air velocity sensor. It is recommended that the measurement is performed in an environment with at least 0.1m/s airflow to obtain accurate readings.

2.3.3 Differential Pressure Measurement Precautions (A041, A044)

- Do not apply pressure more than 75kPa to the pressure sensor. Excess pressure may cause permanent damage to the sensor.
- The operating temperature is 5 - 40°C (or 41 - 104°F) when measuring the pressure. The instrument may not operate properly out of this temperature range.
- Make sure to perform zero adjustment before measuring the pressure. When performing the zero adjustment, leave both pressure ports (+) and (-) open.

<Zero Adjustment Procedure>

Display	Description
	Press MODE key to enter the pressure measurement screen.
	Press and hold the ZERO key for more than 2 seconds. The pressure value will be 0.00 kpa.

<Connecting the Pressure Tube>

Connect the pressure tube to the (+) or (-) pressure port as shown right.

Connect the other end of the tube to the port (e.g. duct) where the pressure is to be measured.

When the pressure to be measured is positive, connect the tube to the (+) port, and when it is negative, connect the tube to the (-) port.

In order to take an accurate measurement, make sure that the tube is properly secured without any leakage, or being bent.

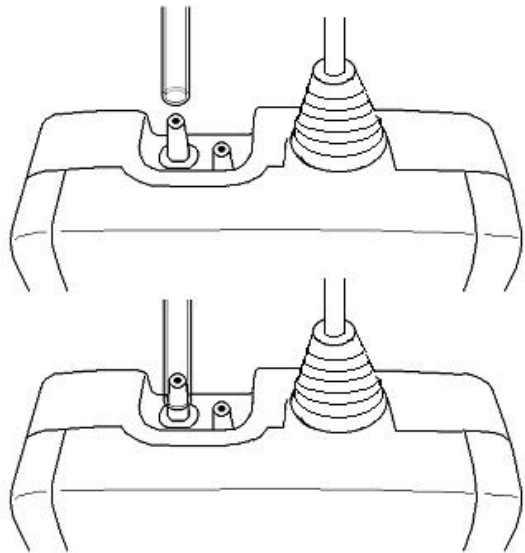

3. Duct Shape and Size







Before measuring the volumetric flow rate, duct shape and size setting must be made.

Duct Shape: There are two duct shapes - Rectangular and Circular, which are indicated as and at the lower right corner of the LCD screen.

Size of duct: For a rectangular duct, set the width (W) and height (H).
For a circular duct, set the diameter (D).

Size Range: Maximum dimension of a side: 2550mm
Input Increment: Range of 0 to 1000mm: 1mm
Range of 1000 to 2550: 10mm

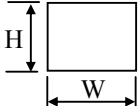
*When inch is selected for the input unit, maximum dimension will be 255 inch.
Input Increment: Range of 0 to 100 inch: 0.1 inch
Range of 100 to 255 inch: 1 inch

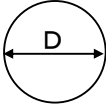
Display	Description	
	Press <input type="button" value="SHAPE"/> key to enter the setting screen.	
	<Setting of a Rectangular Duct> Select <input type="checkbox"/> with the <input type="button" value="▼"/> <input type="button" value="▲"/> keys, and press the <input type="button" value="ENTER HOLD"/> key.	
	<Setting of a Circular Duct> Select <input type="radio"/> with the <input type="button" value="▼"/> <input type="button" value="▲"/> keys, and press the <input type="button" value="ENTER HOLD"/> key.	
	<Setting the Dimension for a Rectangular Duct> Set the height (H) value with the <input type="button" value="▼"/> <input type="button" value="▲"/> keys, and press the <input type="button" value="ENTER HOLD"/> key.	
	Set the width (W) value with the <input type="button" value="▼"/> <input type="button" value="▲"/> keys, and press the <input type="button" value="ENTER HOLD"/> key.	
	<Setting the Dimension for a Circular Duct> Set the diameter (D) with the <input type="button" value="▼"/> <input type="button" value="▲"/> keys, and press the <input type="button" value="ENTER HOLD"/> key.	

4. Measurement

When the instrument is turned on, the LCD test screen will be displayed for approx. 2 seconds. The test screen will then switch to the Air Velocity / Air Temperature measurement screen. The reading will be updated each second.

4.1 Changing the Measurement Mode

To change the measurement mode, press the **MODE** key while each measurement screen is displayed. The screen will switch in the following sequence.

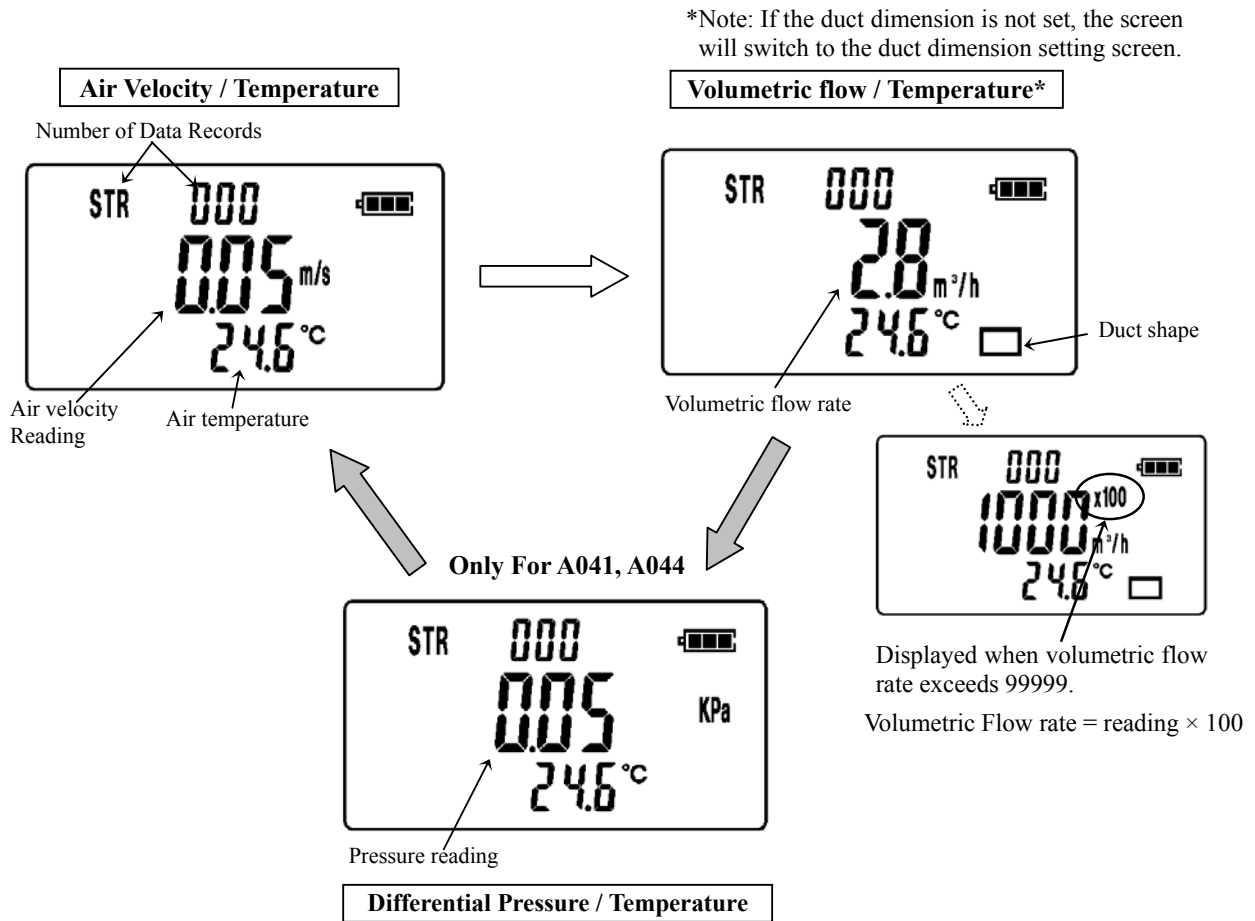

4.2 Hold the Reading

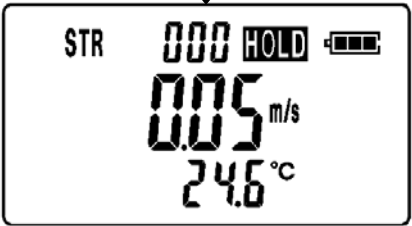

Display	Description
	<p>While measuring, press the ENTER HOLD key to hold the current reading.</p>
	<p>HOLD mark will be displayed at the upper right of the reading while the reading is held.</p>
	<p>To recover from the hold mode, press the ENTER HOLD key again.</p>
	<p>By pressing the STORE key while the reading is held, the displayed reading will be saved temporarily in the memory, and hold mode will be released to resume measurement.</p>
	<p>For how to store the data, refer to Section 5.2 “Data Storage and Statistical Calculation Procedure” (P.15).</p>

4.3 Setting the Time Constant

When there is rapid change in the measurement data, the readings may become difficult to read. In such case, the speed of updating the readings can be reduced by changing the time constant setting.

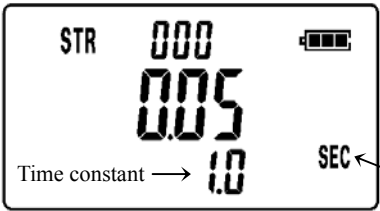

Time constant determines the time span of the moving average. When a larger (longer) time constant is selected, the readings will be rather stable, and when a smaller (shorter) time constant is selected, the readings will be more responsive and sensitive to the change.

The time constant can be selected from 1, 5, 10 or 20 seconds by pressing the  key.

Display	Description
 <p>The display shows 'STR 000' at the top left, a battery level indicator at the top right, and '0.05' in the center. Below '0.05' is '20.0' and 'SEC' to its right. At the bottom left, it says 'Time constant → 1.0'. An arrow points from the text 'Time cons. unit' to the 'SEC' label.</p>	<p>< Time Constant Setting Screen ></p> <p>By pressing the  key in a measurement mode, the display will switch to the time constant setting screen.</p>

EXAMPLE when setting the time constant to 20 seconds:



Select the time constant “20.0” by pressing the   keys, and press the  key .

Time constant can be set only for the Air Velocity and Volumetric Flow measurements.

Note: The time constant selected from 1, 5, 10 and 20 seconds will be initialized once the power is turned off, and will return to the default setting of 1 second.

5. Data Storage and Statistical Calculation



5.1 Storing Measurement Data



Measurement data can be stored in the built-in memory of the instrument. The instrument can hold up to 800 data records. When storing the measurement data, average, maximum and minimum values will be calculated for the data group to be stored. Each data group is stored with a storage number (shown as **DN_o xxx**) which starts from 001 for each mode. Contents of the data stored in each measurement mode are shown in the following table.

Measurement Mode	Stored Data
Air Velocity / Air Temperature	Air Velocity, Air Temperature and Data Storage No.
Volumetric Flow Rate / Air Temperature	Volumetric Flow Rate, Air Temperature, Data Storage No., and Duct Shape/Size
Pressure / Air Temperature	Pressure, Air Temperature, and Data storage No.

5.2 Data Storage and Statistical Calculation Procedure

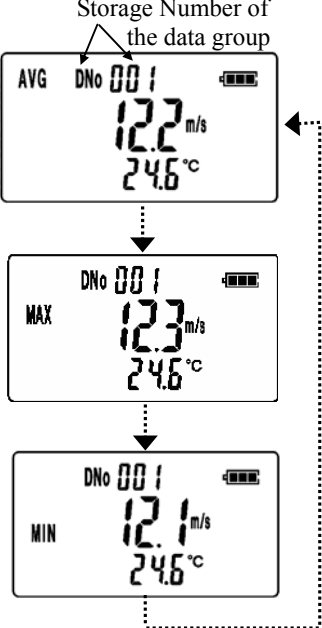
Data storage procedure will be described below by taking an example of an operation in the “Air Velocity / Air Temperature Measurement Mode”. Data storage procedure is same in other modes as well.

Display	Description
<p>①</p> <p>Number of stored data records</p> 	<p>< Temporary Data Storage ></p> <p>By pressing the STORE key while measuring, the current reading will be stored in the temporary memory.</p> <p>NOTE:</p> <ol style="list-style-type: none"> Temporary Memory -- Data will be cleared once measurement mode is changed or power is turned off. Number of Stored Data Records -- Indicates the number of data records stored in the temporary memory.
<p>②</p> 	<p>The displayed reading will be stored in the temporary memory each time the STORE key is pressed, and the number of stored data records will increase by one. A maximum of 800 data records can be stored.</p>
<p>③</p> 	<p>< Data Storage and Statistical Calculation ></p> <p>Press the CALC key to execute the statistical calculation (Average, Maximum and Minimum) for the group of data records stored in the temporary memory.</p>
<p>④</p> <p>Storage Number of the data group</p> 	<p>Average value will be displayed with the Storage Number of the data group.</p> <p>Display will switch in the sequence shown left (AVG→MAX→MIN) as you press the CALC key.</p>











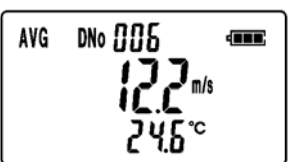

Display	Description
⑤ 	<p>< Storing the Calculation Result ></p> <p>To store the calculation result, press the STORE key while either average, maximum or minimum value is displayed. The calculation data will be stored as a data group. The display will return to the original measurement mode and the temporary memory will be cleared.</p>
⑥ 	<p>< To Clear the Data Group ></p> <p>To clear the data group without saving, press and hold the CLEAR key while either average, maximum or minimum value is displayed.</p> <p>NOTE: Data records in the temporary memory and the calculation result will be cleared.</p>
⑦ 	<p>CLEAR will be displayed, and the screen will return to the original measurement mode.</p>

5.3 Viewing and Deleting Stored Data

The average, maximum and minimum value of the stored data can be viewed on the display and deleted. Only the calculation result can be viewed from the instrument. To view each data of the data group, the data must be printed out from an optional printer (please refer to section 7 “Data Output” P.19).

When deleting the stored data, the calculation result and each data of the selected data group will be deleted.

Data viewing and deleting procedure will be described below by taking an example of an operation in the “Air Velocity / Air Temperature Measurement Mode”.

Display	Description
① 	<p>< Viewing the Stored Data ></p> <p>Press the  key when the instrument is in the measurement mode in which the data is stored.</p> <p>The most recently stored average value (AVG) will be displayed. (Figure ②)</p>
② 	<p>< Viewing Other Data ></p> <p>By pressing the  key, maximum, minimum and average value of the data group can be viewed.</p> <p>To move to the previous/next data group, press the   keys.</p>
③ 	<p>< Exit from Data Viewing ></p> <p>Press the  key to exit (cancel) data viewing.</p> <p>When cancelled, the screen will return to the measurement mode. (Figure ①)</p>
④ 	<p>< Deleting the Stored Data Group ></p> <p>Select the data group (Figure③) to be deleted, and press the  key. The air velocity value will start blinking (Figure④).</p> <p>- To delete the selected data, press the  key again. When pressed, CLEAR will be displayed (Figure ⑤).</p> <p>- To delete All data groups stored in the relevant measurement mode, press and hold the  key for approx. 5 seconds until CLEAR is displayed. All Data Groups stored under this mode will be cleared.</p>
⑤ 	<p>After CLEAR is displayed, the screen will return to the measurement mode.</p>

6. Setting the Measurement Unit and Baud Rate

List of Measurement Units:

- Air velocity: m/s, FPM
- Air temperature: °C, °F
- Volumetric flow rate: m³/h, m³/min, ft³/min
- Length: mm, inch





< Unit Conversion Table >

Air Velocity: 1m/s=196 FPM
 Air Temperature: $T(^{\circ}\text{F})=1.8\times T(^{\circ}\text{C})+32$
 Volumetric Flow: $1\text{m}^3/\text{h}=35.32\text{ft}^3/\text{h}$
 Length: 1inch=25.4mm

RS232C Communication Baud Rates:

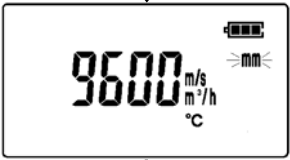
4800bps, 9600bps, 19200bps, 38400bps

Procedure for setting the Units and Baud Rate.

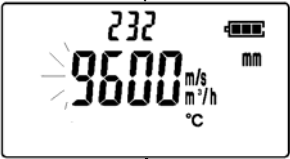
Display	Description
	<p>Measurement Mode</p> <p>Press the <input type="button" value="UNIT"/> key to enter the unit setting mode.</p>
	<p>Length Unit</p> <p>The unit to be set will blink.</p> <p>Use the <input type="button" value="▼"/> <input type="button" value="▲"/> keys to select the unit. Press the <input type="button" value="ENTER HOLD"/> key to save the setting and to proceed to the next unit setting.</p>
	<p>Air Velocity Unit</p> <p>Repeat the above procedure for each unit.</p>
	<p>Volumetric Flow Unit</p>
	<p>Air Temperature Unit</p>
	<p>Baud Rate</p>

NOTE:

- The saved setting will be kept even when the instrument is turned off.
- To exit (cancel) the unit/ baud rate setting, press the "MODE" key. Any setting saved before then is valid.

7. Data Output

7.1 Printing Out the Measurement Data

To print out the stored measurement data, an optional printer and printer cable are required. The printer cable must be connected to the RS232C terminal located at the side of the instrument.

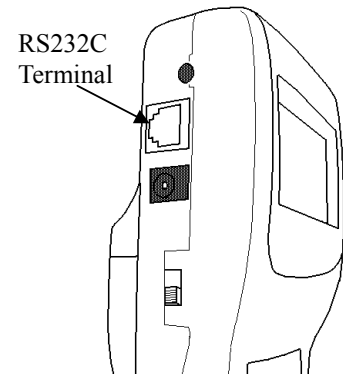

7.1.1 Preparation for Print Out

Equipment (Optional)

- Printer
- Printer Cable

< Communication Protocol >

The baud rate setting of the instrument and printer must be consistent.

List of Communication Protocol:

Data Bit Length	8 bit
Parity	None
Stop Bit	1
Delimiter	CRLF
Baud Rate	Set Value*

* For how to set the baud rate of the instrument, refer to Section 6 “Setting the Measurement Unit and Baud Rate”.





* For setting the printer, please refer to the operational manual of your printer.

< Connecting the Printer and the Instrument >

1. Connect the printer and the instrument with the printer cable by inserting the printer cable in the RS-232C terminal located at the side of the instrument.
2. **Turn on the power of the instrument first**, and then turn on the printer.
3. Confirm that the instrument is in the measurement mode.

7.1.2 Printing Directly from the Measurement Mode

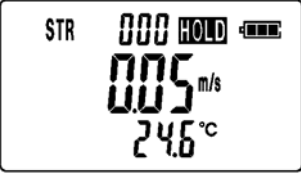
Procedure for printing directly from the measurement mode will be described below taking an example of an operation in the “Air Velocity / Air Temperature Measurement Mode”.

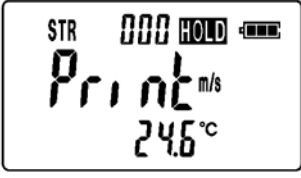









	Display	Description
①		Hold the reading by pressing the  key.
②		HOLD sign will be displayed at the upper right part of the LCD screen. Press the  key to execute printing.
③		While printing, <i>Print</i> will be displayed on the screen. When printing is complete, the screen will return to the measurement screen with the reading held. Measurement can be resumed by releasing the hold mode.

7.1.3 Printout Examples (Measurement Mode)

Measurement Modes		
Air Velocity / Air Temperature	Volumetric Flow / Air Temperature	Pressure / Air Temperature
<p>EXAMPLE:</p> <p>Vel 0.15m/s Temp 21.8 °C</p>	<p>EXAMPLE: (When duct shape is Rectangular.)</p> <p>Duct Shape R Size 2550*2550mm FlowRate 407.3 m3/h Temp 22.5 °C</p> <hr/> <p>EXAMPLE: (When duct shape is Circular.)</p> <p>Duct Shape C Size 2550mm FlowRate 407.3m3/h Temp 23.6 °C</p>	<p>EXAMPLE:</p> <p>Press 1.03 KPa Temp 20.1 °C</p>

7.1.4 Printing Out Stored Data

Procedure of printing the stored data will be described below by taking an example of printing the sixth data group stored in the “Air Velocity / Air Temperature Measurement Mode”.

	Display	Description
①		<p>Press the  key in the measurement mode. The most recently stored average value will be displayed (Figure ②).</p>
②		<p>Select the Data group to be printed by using the   keys. When selected, press the  key and the reading will start blinking (Figure ③). Connect the printer.</p>
③		<p>Press the  key again to execute printing. On the screen, <i>Print</i> will be displayed (Figure ④). To print all data group stored in this mode, press and hold the  key for approx. 5 seconds until <i>Print</i> appears on the screen. All data stored under the relevant mode will be printed out continuously.</p>
④		<p>When printing is complete, the display will return to the measurement mode (Figure ①).</p>
	<p>< Error Message ></p> 	<p>If the printer is not connected when executing print, an error message will be displayed for approx. 2 sec, and the screen will return to the measurement mode (Figure ①).</p>

7.1.5 Printout Examples (Stored Data)

Measurement Modes		
Air Velocity / Air Temperature	Volumetric Flow / Air Temperature	Pressure / Air Temperature
<p>EXAMPLE for group DNo006</p> <p>DNo.006</p> <p>001 Vel 0.15m/s Temp 21.8 °C</p> <p>002 Vel 0.16m/s Temp 21.8 °C</p> <p>003 Vel 0.14m/s Temp 21.8 °C</p> <p>004 Vel 0.13m/s Temp 21.8 °C</p> <p>AVG Vel 0.15m/s Temp 21.8 °C</p>	<p>EXAMPLE for group DNo006 (When duct shape is Rectangular.)</p> <p>DNo.006 Duct Shape R Size 2550*2550mm</p> <p>001 FlowRate 407.3 m3/h Temp 22.5 °C</p> <p>002 FlowRate 405.6 m3/h Temp 22.5 °C</p> <p>003 FlowRate 400.9 m3/h Temp 22.5 °C</p> <p>004 FlowRate 401.4 m3/h Temp 22.5 °C</p> <p>AVG FlowRate 403.8 m3/h Temp 22.5 °C</p>	<p>EXAMPLE for group DNo006</p> <p>DNo.006</p> <p>001 Press 1.03 KPa Temp 20.1 °C</p> <p>002 Press 1.02 KPa Temp 20.1 °C</p> <p>003 Press 1.01 KPa Temp 20.1 °C</p> <p>004 Press 1.00 KPa Temp 20.1 °C</p> <p>AVG Press 1.02 KPa Temp 20.1 °C</p>
	<p>EXAMPLE for group DNo005 (When duct shape is Circular.)</p> <p>DNo.005 Duct Shape C Size 2550mm</p> <p>001 FlowRate 407.3m3/h Temp 23.6 °C</p> <p>002 FlowRate 405.6m3/h Temp 23.6 °C</p> <p>003 FlowRate 400.9m3/h Temp 23.6 °C</p> <p>004 FlowRate 401.4m3/h Temp 23.6 °C</p> <p>AVG FlowRate 403.8m3/h Temp 23.6 °C</p>	

7.2 Analog Output (Optional)

Analog output is limited to the output of air velocity in the Air Velocity / Air Temperature Mode.

1. Data update interval..... 0.1sec
2. Load impedance.....5KΩ and above
3. Output voltage..... DC 0~3V (0~30m/s)
4. Polarity of output voltage..... ⊖ ⊙ ⊕

Analog output terminal

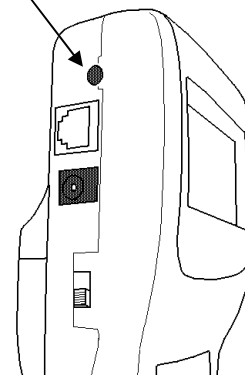

7.3 S232C Serial Communication

For serial communication, the RS232C cable must be connected to the RS232C terminal located at the side of the instrument.

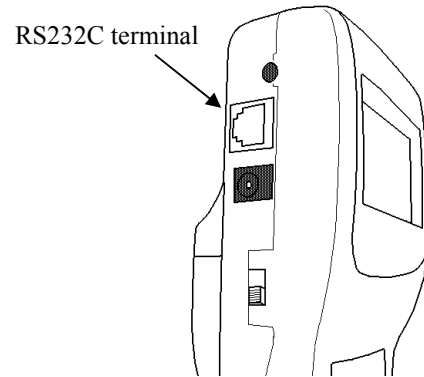

<Equipment >

- Computer
- RS232C Communication Cable
- Communication Software

(PC-LINK Software: For transferring stored data to the PC.

Data Acquisition Software: For transferring real time data to the PC.)

<Baud Rate>

The baud rate will be set automatically by the communication software.

<Connecting the Instrument with a Computer>

1. Turn off the instrument.
2. Connect the instrument to a computer with the RS232C communication cable.
3. Turn on the instrument.
4. Confirm that the instrument is in normal measurement mode.

RS232C Cable Wiring Diagram

Computer (D-Sub9 pin)		Connection	ANEMOMASTER (Model A031/A034/A041/A044)			
Signal	Pin No.		Pin No.	Signal	Description of Signal	Signal Direction
NC	1		1	GND	Signal Ground	
RXD	2		2	TXD	Transmit Data	Output
TXD	3		3	RXD	Receive Data	Input
NC	4		4	CTS	Clear to Send	Input
GND	5		5	RTS	Request to Send	Output
NC	6		6	NC		
RTS	7					
CTS	8					
NC	9					

* Refer to the operation manual provided with the software for the operation procedure.

8. Cleaning the Probe

When the sensor is contaminated with impurities such as dust, particles, soot or machine oil, the heat dissipation rate will change. In most cases, heat dissipation will decrease, resulting in lower air velocity readings.

This is same for the probes which are equipped with a mesh cover. The same problem will occur if the mesh is deformed, or clogged with impurities.

If impurities are attached to the sensor or mesh from using the instrument in an unclean environment, it is recommended that the sensor is cleaned right after use.

Method of Cleaning

Clean the sensor of the probe in an ultrasonic cleaner for approx. 10-20 sec.

Do not clean the sensor longer than required as excess cleaning will lead to sensor coating damage.

Use water for cleaning.

The sensor can also be cleaned in a vessel filled with neutral detergent diluted with water, and by gently stirring it in the vessel.

! Caution !

!) Make sure to TURN OFF the power before cleaning.

!) Dry the probe completely after cleaning. Do not turn on the power before completely dried.

9. Specifications

Product		Anemomaster
Model		A031, A041, A034, A044
Measuring Object		Clean Air Flow
Measuring Range (Resolution)	Air Velocity	0.10 to 30.0 m/s (0.00 to 9.99m/s: 0.01m/s, 10.0 to 30.0m/s: 0.1m/s)
	Air Temperature	-20.0 to 60.0 °C (0.1°C)
	Pressure* ¹	-5.00 to +5.00 kPa (0.01kPa)
Duct Size Range		0 to 2550mm (0 to 255inch)
Accuracy	Air Velocity	± (3% of the reading +0.1) m/s
	Air Temperature	± 0.5 °C
	Pressure* ¹	± (3% of the reading +0.01) kPa
Response Time	Air Velocity	Approx. 1sec. (at Air Velocity: 1 m/s, 90% Response)
	Air Temperature	Approx 30sec. (at Air Velocity: 1 m/s, 90% Response)
	Pressure* ¹	Approx 1 sec.
Temperature Compensation Accuracy (Velocity)		± (5% of the reading +0.1)m/s in temperature range of 5 to 60°C
Sampling Functions		<ul style="list-style-type: none"> - Hold the reading - Statistical calculation (Average, Maximum, Minimum) - Time constant setting (1, 5, 10, 20 sec) - Remaining battery level indicator (4 levels) - Selection of sampling units (Air velocity: m/s or ft/min; Flow rate: m³/h, m³/min or ft³/min; Air temperature: °C or °F) - Data storage: Max. 800 data records. - Duct shape setting : Rectangular or Circular / Duct size unit: mm or inch
Output		Digital output: RS232C (Baud rate: 4800, 9600, 19200, 38400bps) for outputting to printer and PC. Analog output* ² : DC 0 to 3V (Only for air velocity output)
Power		Manganese AA Batteries × 6 (Alkaline or Ni-Cd batteries can be used as well) AC Adapter: AC 100 to 240V (50/60Hz)
Battery Life		Approx. 10 hours (when, Air velocity: 5m/s, Air temp: 20°C, and using Alkaline batteries)
Operating Environment	Main Unit	5 to 40°C
	Probe	-20 to 60°C
	Storage Temperature	5 to 40°C
Weight		Approx. 500g (Including Batteries)
Standard Accessories		Carrying case, Operation manual, Manganese AA Batteries × 6, RS232C cable, Software (for Windows), and AC adapter
Optional Accessories		Analog output, Printer, AC adapter for the printer

*1: Pressure measurement is only available for A041 and A044

*2: Optional

10. Measurement Principles

Hot-wire Anemometer Principle

When the heated air velocity sensor is exposed to airflow, the sensor temperature will change by the heat drawn by the airflow. Accordingly, the sensor resistance value will change. This change in the resistance value will vary largely as the air velocity increases. Therefore, if the relationship between the air velocity and the resistance value is known, the air velocity can be obtained by measuring the resistance value (or current).

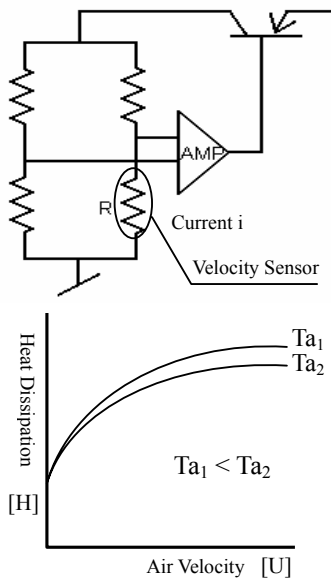
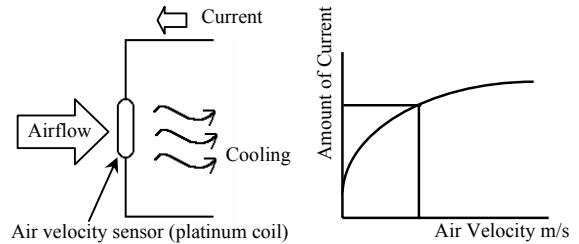

The *Anemomaster* anemometer is based on the above principle.

Generally, a hot-wire anemometer employs a feedback circuit to control the sensor to maintain constant temperature. (Constant Temperature Type)

When there is a change in the air velocity, the heat drawn from the sensor (heat dissipation) will change accordingly. In order to maintain constant temperature, current is applied to the sensor to compensate this change. Thus, the air velocity value can be obtained from the amount of the applied current (i).

The amount of heat [H] drawn from the air velocity sensor can be expressed by the following formula.

$$H = (a + b\sqrt{U})(T - Ta) \text{ --- King's Formula}$$

Where;

H: Heat Dissipation T: Sensor Temperature Ta: Air Temperature
 U: Air Velocity a,b: Constant

The Heat Dissipation [H] can also be expressed by the following formula from the sensor resistance (R) and current (i).

$$H = RI^2$$

(R is kept constant regardless of the air velocity change)

Thus: $RI^2 \propto a + b\sqrt{U}$

As shown by this formula, the change in the air velocity “U” can be interpreted as the change in the current “i”.

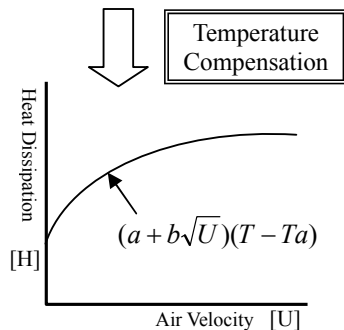

➤ Temperature Compensation

When the air temperature changes, the amount of heat dissipation will change accordingly even when the air velocity is constant. Thus, *Anemomaster* employs a temperature compensation circuit to enable accurate air velocity measurement by eliminating the influence of the temperature change. For this purpose, a temperature measurement sensor R_c having the same temperature coefficient as the air velocity is provided at the opposite side of the bridge, and the bridge is adjusted so that the difference with the air temperature (T-Ta) is kept constant.

➤ **Air Temperature Measurement**

An air temperature element (platinum thin film element) which its resistance value changes by the air temperature is incorporated in one side of the bridge. The air temperature can be obtained by measuring the variance in the resistance value.

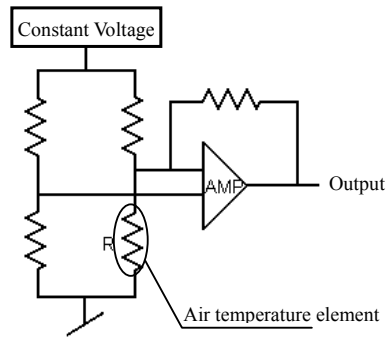

➤ **Pressure Measurement (A041, A044)**

A diffusion-type semiconductor pressure sensor is employed to measure the pressure. This diffusion-type semiconductor pressure sensor is based on the Piezoresistance Effect, in which the resistance value changes when the pressure is applied. It is configured with four (4) diffusion resistances (sensor chips) located on the thin silicon diaphragm (Fig. 1).

The pressure is applied from above the pressure sensors, and when the diaphragm is deflected as shown in Fig. 2, compressive stress is applied to R3 and R4 which are located at the center of the diaphragm, and tensile stress is applied to R1 and R2. The resistance value of the diffusion resistance changes in accordance with the strength of the stress applied.

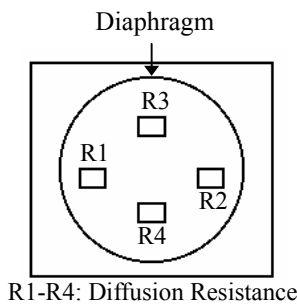

R1-R4: Diffusion Resistance
Fig.1 Pressure Sensor

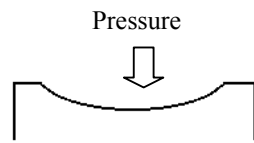

Fig.2

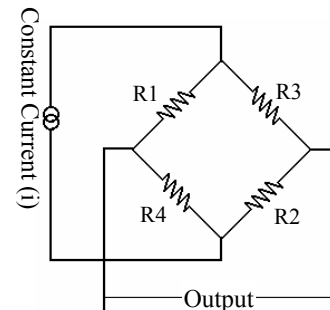

Fig.3 Detection Circuit

By configuring the bridge of the detection circuit with these diffusion resistances, voltage that is proportional to the pressure can be obtained. In addition, since the diffusion resistance is dependent on temperature, temperature compensation resistance is employed for the resistance.

11. Air Velocity Compensation

When the heated air velocity sensor of the instrument is exposed to airflow, the heat is drawn from the sensor. The instrument obtains air velocity readings by using this relationship between the amount of heat removed (heat dissipation) and air velocity.

Since the instrument is calibrated with clean airflow with normal temperature and pressure, when the condition of air to be measured is different from that of the air used for calibration, the heat dissipation amount will differ even when the velocity is consistent (i.e. velocity reading is influenced by the condition of air).

11.1 Influence of Air Temperature

The instrument is a hot-wire anemometer, which measures the air velocity by using the heat dissipation amount. Thus, if temperature compensation is not provided, air velocity readings will be affected by the ambient air temperature change even when the air velocity is consistent. In order to prevent such influence, the instrument is equipped with a temperature compensation circuit for measuring and compensating the air temperature in the range of 5°C to 60°C.

11.2 Influence of Atmospheric Pressure

The instrument is calibrated under atmospheric pressure of 1013hPa. Since change in the atmospheric pressure will influence the heat dissipation amount, compensation of the atmospheric pressure is required. Compensation can be provided by using the following formula.

$$U_m = \frac{1013}{P_m} \times U_c$$

Where, U_m : Actual Air Velocity [m/s]

U_c : Air Velocity Reading

P_m : Atmospheric Pressure at the Time of Sampling [hPa]

11.3 Influence of Air Composition

Compensation is required if the measurement is to be performed in an environment including any gas other than air.

Compensation shall be performed by calculating the heat dissipation amount from the physical properties of the gas, and comparing it with the heat dissipation amount of the air.

12. Probe Directivity (Air Velocity)

12.1 Horizontal Directivity

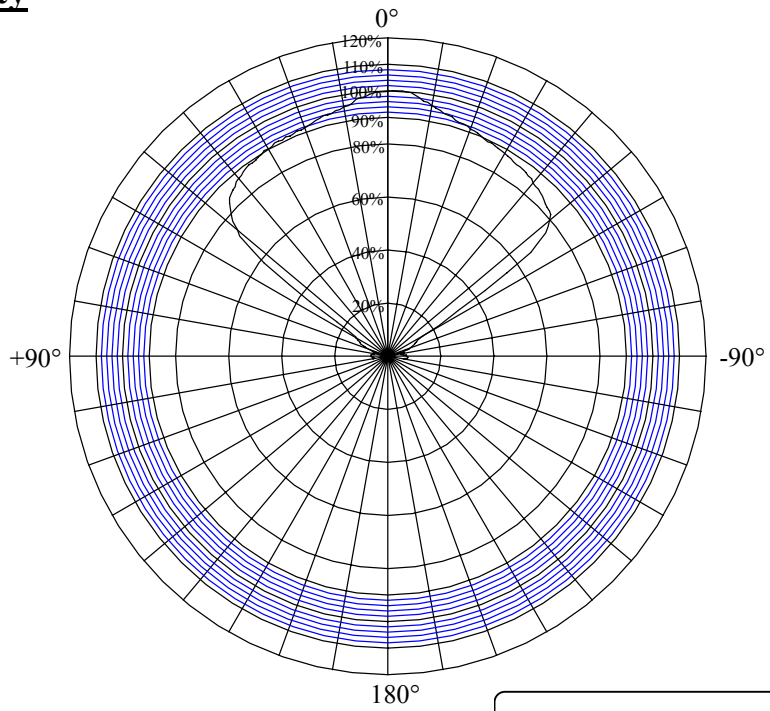
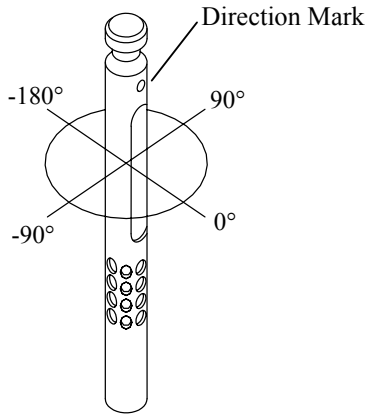

When Air Velocity is 5m/s

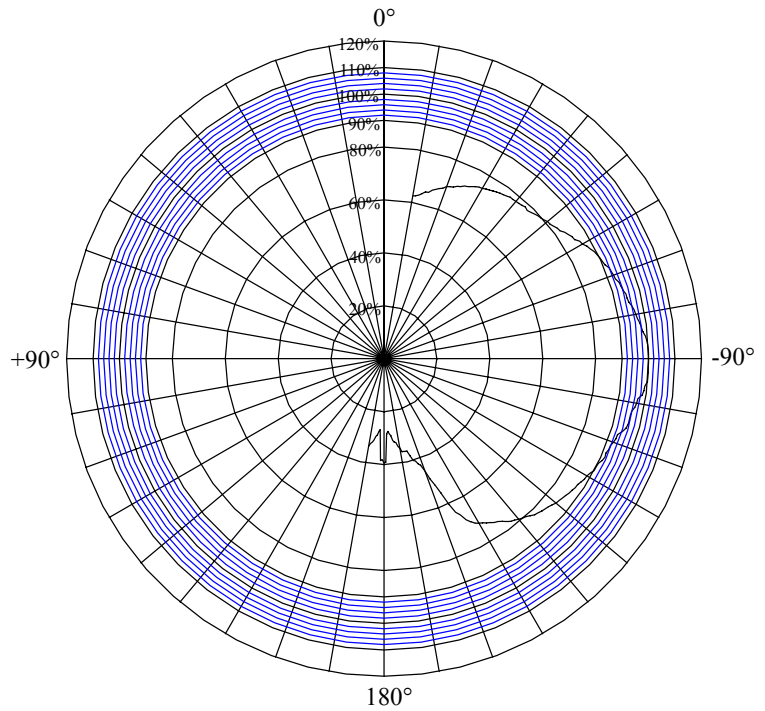
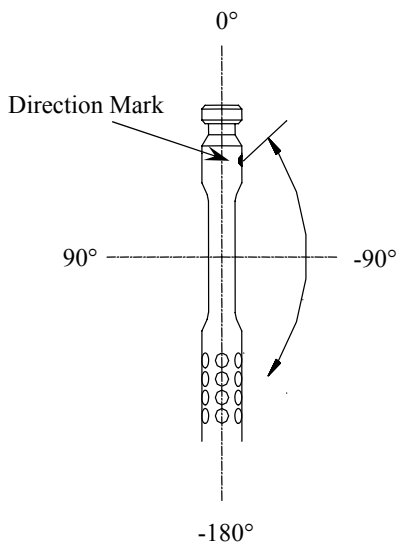

12.2 Vertical Directivity







When Air Velocity is 5m/s

13. Troubleshooting

13.1 Troubleshooting

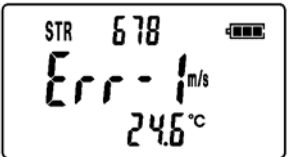
Symptom	Possible Cause / Solution	Refer To (Page No.)
Display does not appear when power is turned ON.	Battery is inserted in wrong polarity. → Turn off the power and insert the battery correctly.	5
	Battery is drained. → Turn off the power and replace the batteries.	5, 6
“  ”blinks	Battery is drained. → Turn off the power and replace the batteries.	5, 6
Reading is displayed as “-----”.	Measurable range is exceeded. → The instrument must be used in the specified measurement range.	25
	Probe wire disconnection or sensor damage. → Contact your local distributor for repair	33, 34
Incorrect air velocity reading.	Confirm that the direction mark of the probe is facing against the airflow direction.	8
	Sensor of the probe is dirty. → Turn off the power, and clean the sensor.	24
High air temperature readings.	Correct reading cannot be obtained when there is no airflow. Minimum 0.1m/s velocity is required for measurement.	8
Air velocity reading does not change from “0.0” when sampling in Volumetric Flow / Air Temperature measurement mode.	Duct shape and dimension settings are not made properly (setting is zero). → Provide correct duct shape/dimension settings.	10
Printing Failure	Confirm that the printer cable is connected properly.	19
	Printer is not connected in the right order. → After connecting the printer, turn on the instrument first, and then turn on the printer.	19
	Baud rate is not set properly. → Confirm the instrument and printer settings.	18
Data Transfer Failure	Confirm that the RS232C cable is connected properly. Make sure that it is not confused with the printer cable.	23
Analogue Output Failure	Confirm that the polarity of the output terminal is correct.	22
	The reading is in “hold” mode. → Press the  key to release the hold mode.	12
Incorrect Output Value	Load impedance is set lower than the specified value. → Load impedance must be set to 5K Ω and over.	22

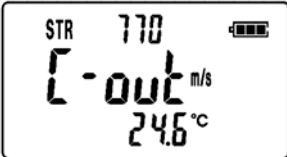
13.2 Various Status Displays

Display	Description
	The number of stored data records has exceeded the maximum limit of 800 data records. Stored data must be deleted to enable further data storage.
	Printing failure. Confirm the communication setting and cable connection. Also confirm that the printer is in normal operating condition.
	Communication buffer overflow during data transfer (to printer or PC). Normal operation will be possible once communication is completed.
	Displayed during printing. When you want to cancel printing, press and hold the  key.

14. Warranty and After Service

14.1 Kanomax Limited Warranty

The limited warranty set forth below is given by KANOMAX JAPAN, Inc. (hereafter referred to as “KJI”) with respect to the KANOMAX brand anemometer, and its attachment parts including probe and other accessories (hereafter referred to as “PRODUCT”) purchased directly from KJI or from an authorized distributor.

Your PRODUCT, when delivered to you in new condition in its original container, is warranted against defects in materials or workmanship as follows: for a period of one (1) year from the date of original purchase, defective parts or a defective PRODUCT returned to KJI, as applicable, and proven to be defective upon inspection, will be exchanged for a new or comparable rebuilt parts, or a refurbished PRODUCT as determined by KJI. Warranty for such replacements shall not extend the original warranty period of the defective PRODUCT.

This limited warranty covers all defects encountered in normal use of the PRODUCT, and does not apply in the following cases:

- (1) Use of parts or supplies other than the PRODUCT sold by KJI, which cause damage to the PRODUCT or cause abnormally frequent service calls or service problems.
- (2) If any PRODUCT has its serial number or date altered or removed.
- (3) Loss of damage to the PRODUCT due to abuse, mishandling, alternation, improper packaging by the owner, accident, natural disaster, electrical current fluctuations, failure to follow operation, maintenance or environmental instructions prescribed in the PRODUCT's operation manual provided by KJI, or service performed by other than KJI.

NO IMPLIED WARRANTY, INCLUDING ANY IMPLIED WARRANTY OF MERCHANTABILITY OR FITNESS FOR A PARTICULAR PURPOSE, APPLIES TO THE PRODUCT AFTER THE APPLICABLE PERIOD OF THE EXPRESS LIMITED WARRANTY STATED ABOVE, AND NO OTHER EXPRESS WARRANTY OR GUARANTY, EXCEPT AS MENTIONED ABOVE, GIVEN BY ANY PERSON OR ENTITY WITH RESPECT TO THE PRODUCT SHALL BIND KJI. KJI SHALL NOT BE LIABLE FOR LOSS OF STORAGE CHARGES, LOSS OR CORRUPTION OF DATA, OR ANY OTHER SPECIAL, INCIDENTAL OR CONSEQUENTIAL DAMAGES CAUSED BY THE USE OR MISUSE OF, OR INABILITY TO USE, THE PRODUCT, REGARDLESS OF THE LEGAL THEORY ON WHICH THE CLAIM IS BASED, AND EVEN IF KJI HAS BEEN ADVISED OF THE POSSIBILITY OF SUCH DAMAGES. IN NO EVENT SHALL RECOVERY OF ANY KIND AGAINST KJI BE GREATER IN AMOUNT THAN THE PURCHASE PRICE OF THE PRODUCT SOLD BY KJI AND CAUSING THE ALLEGED DAMAGE. WITHOUT LIMITING THE FOREGOING, THE OWNER ASSUMES ALL RISK AND LIABILITY FOR LOSS, DAMAGE OF, OR INJURY TO THE OWNER AND THE OWNER'S PROPERTY AND TO OTHERS AND THEIR PROPERTY ARISING OUT OF USE OR MISUSE OF, OR INABILITY TO USE, THE PRODUCT NOT CAUSED DIRECTLY BY THE NEGLIGENCE OF KJI. THIS LIMITED WARRANTY SHALL NOT EXTEND TO ANYONE OTHER THAN THE ORIGINAL PURCHASER OF THE PRODUCT, OR THE PERSON FOR WHOM IT WAS PURCHASED AS A GIFT, AND STATES THE PURCHASER'S EXCLUSIVE REMEDY.

14.1 After Service

- When you have a problem with your instrument, please check out the “Troubleshooting” section first.
- If that does not help, please contact your local distributor, or call our service center (See last page for contact information).
- During the warranty period, we will repair at no charge a product that proves to be defective due to material or workmanship under normal use. (See Section 14.1 Kanomax Limited Warranty)
All return shipping charges are the responsibility of the customer.
- Repair after warranty expiration:
Upon request, we will repair the instrument at the customer’s expense, if the instrument’s performance is found to be recoverable by providing the repair.
- Replacement parts are available for a minimum period of five (5) years after termination of production. This storage period of replacement parts is considered as the period during which we can provide repair service. For further information, please contact your local distributor or our service center.

When making an inquiry, please provide the following information.

- (1) PRODUCT name: Anemomaster
- (2) Model Number: A031, A034, A041 or A044
- (3) Serial number: xxxxxx
- (4) Probe number: xxxxxx
- (5) Description of Symptom in detail:
- (6) Data of Purchase: Day, Month and Year

15. Contact Information



U.S.A.

KANOMAX USA, INC.

PO Box 372, 219 Route 206, Andover, NJ 07821 U.S.A.

Tel: (800)-247-8887 / (973)-786-6386 **FAX:** (973)-786-7586

URL: <http://www.kanomax-usa.com/>

E-Mail: info@kanomax-usa.com

JAPAN

KANOMAX JAPAN, INC.

2-1 Shimizu Suita City, Osaka 565-0805, Japan

TEL: 81-6-6877-0183 **FAX:** 81-6-6879-2080

URL: <http://www.kanomax.co.jp/>

E-Mail: sales@kanomax.co.jp

CHINA

Shenyang Kano Scientific Instrument Co., Ltd

No. 12, 4 Jia Wencui Road Heping District

Shenyang City PRC

TEL: 86-24-23845309 **FAX:** 86-24-23898417

URL: <http://www.kanomax.com.cn/>

E-Mail: sales@kanomax.com.cn